

iH5

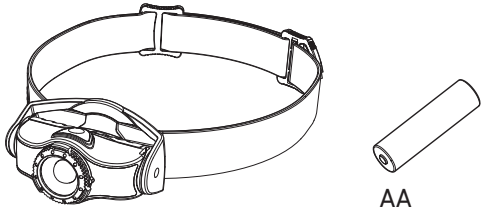

iH5R

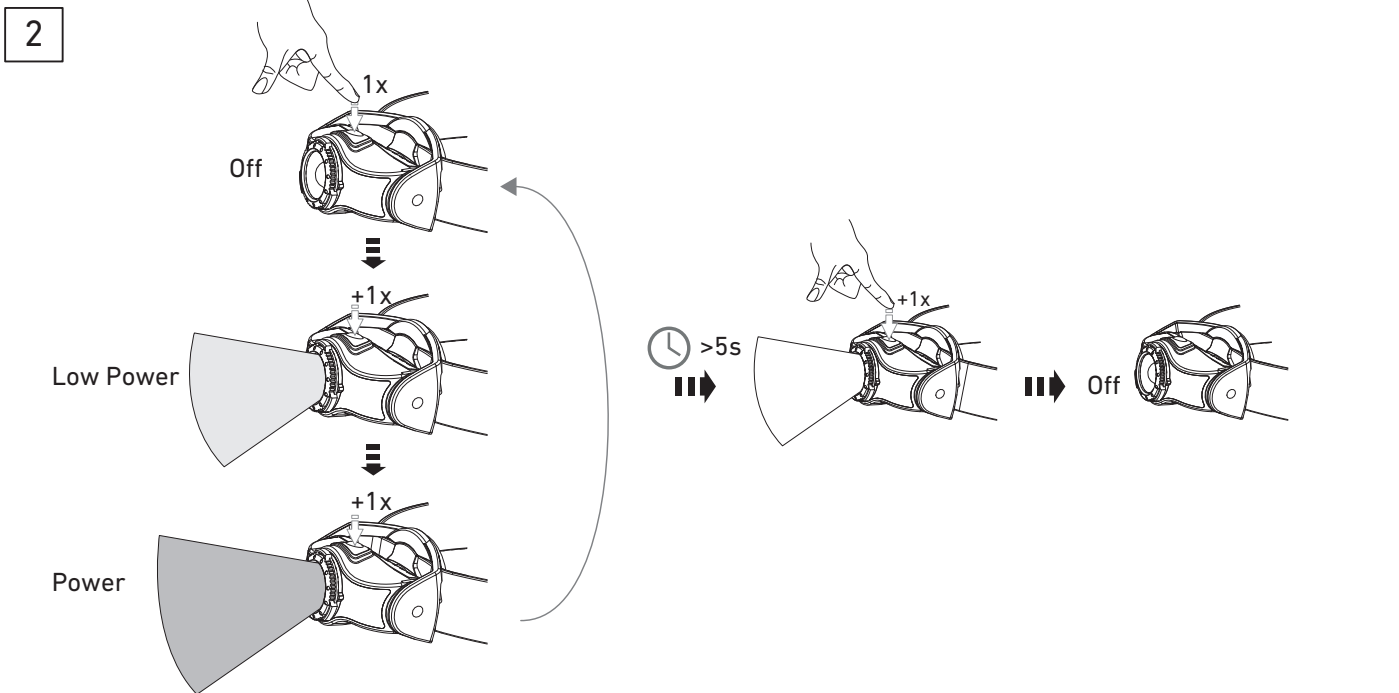
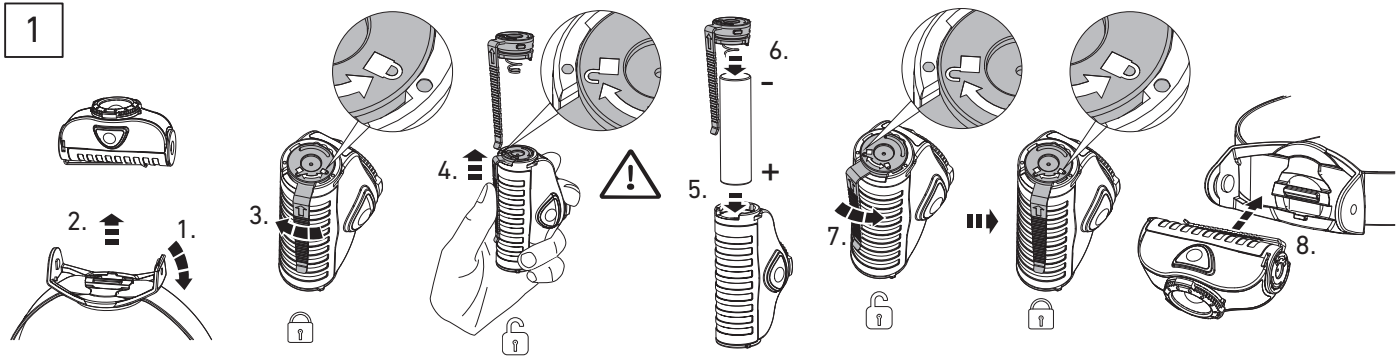
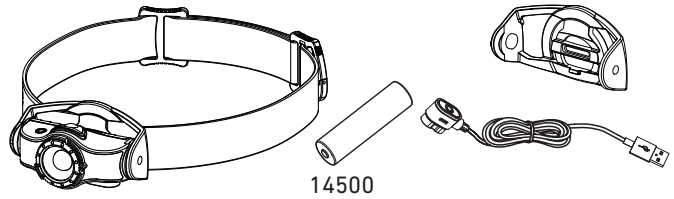

3

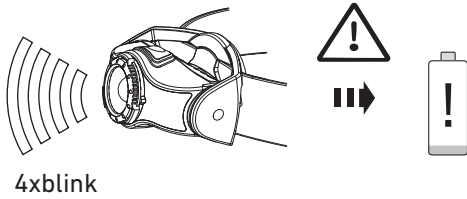

5

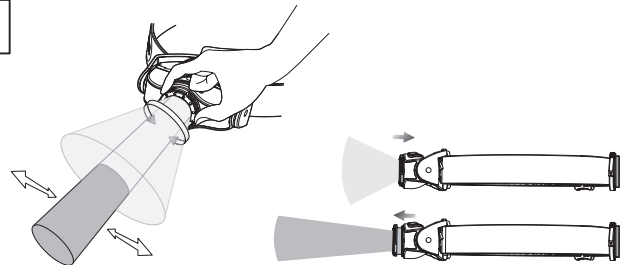

4

iH5R

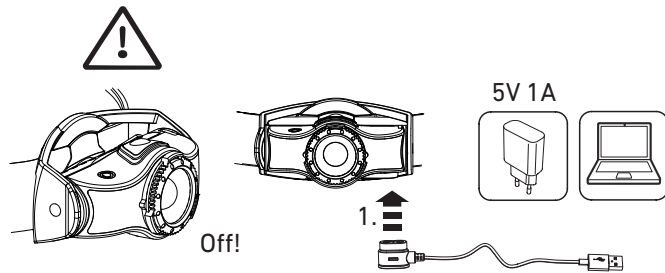

6

iH5R

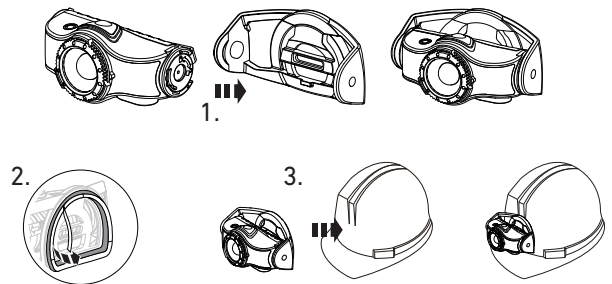

7

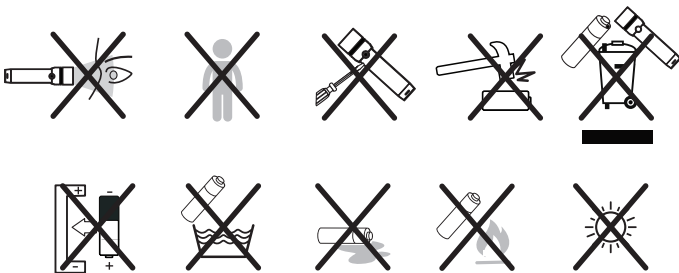
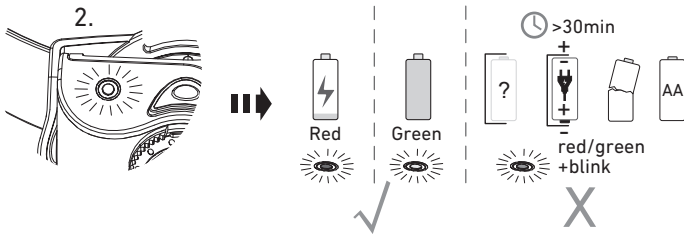
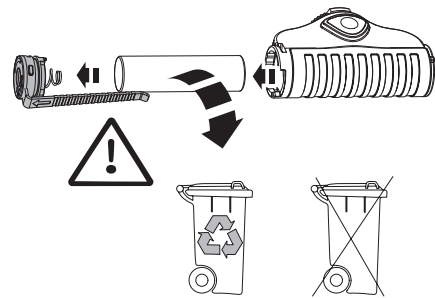

Ledlenser GmbH & Co. KG  
 Kronenstr. 5-7 • 42699 Solingen • Germany  
 Phone +49 212/5948-0 Fax +49 212/5948-200  
 info@ledlenser.com



ledlenser.com



iH5/iH5R V.01  
 05.12.2018  
 1J12A0283